

With Trim

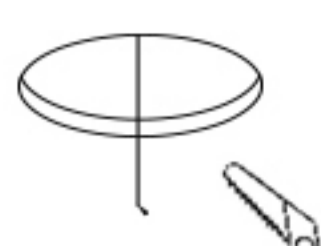

1. cutout on the ceiling
cutout size: **75mm (2.95")**

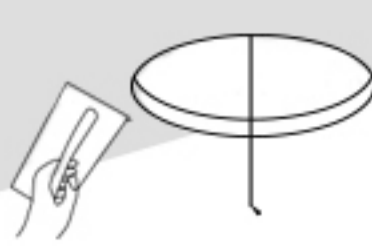

2. plaste-mesh-putty-paint,
finish the ceiling

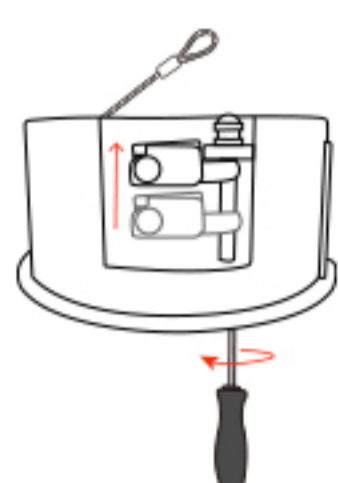

Step1

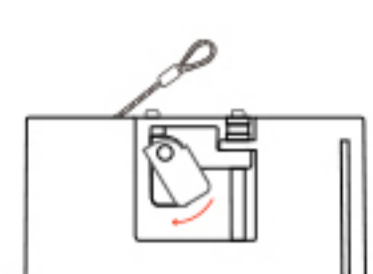

Step2

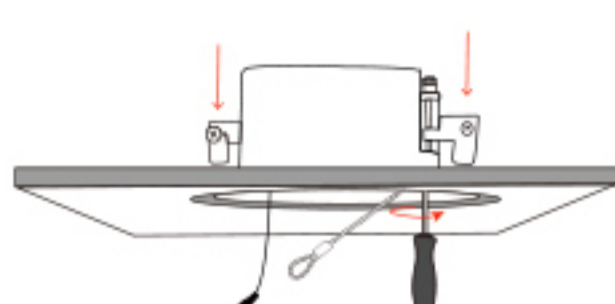

3. after the paint dry enough, install the embedded part
screwed the mount part at a proper position, to fit the ceiling board thickness



4. wire the driver



5. plug in the light, and buckle the
safety rope



6. fix the light on by magnet



7. done

Trimless

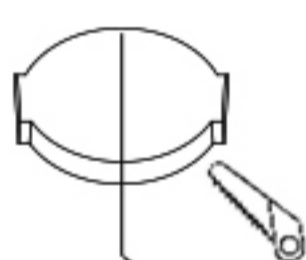

1. cutout on the ceiling
cutout size: **75mm (2.95")**

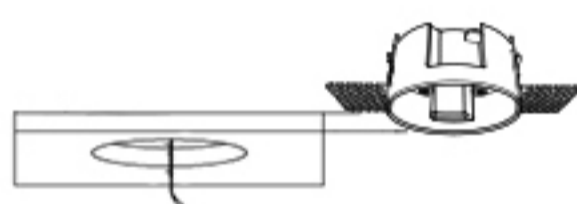
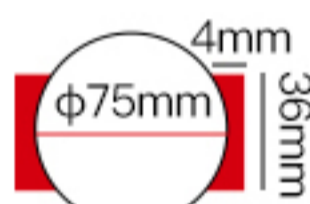

2. adjust the embedded
part height, flush with the
gypsum ceiling/drywall



3. install the embedded
part

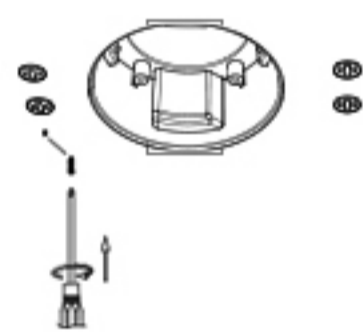

4. fix it with screws

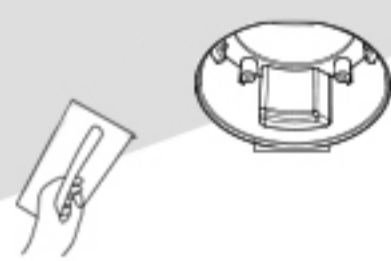

5. plaster-mesh-putty-
paint

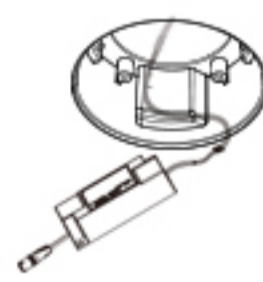

6. wire the driver

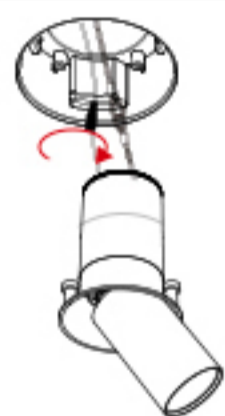

7. plug in the light,
and buckle the safety rope



8. fix the light on by magnet



9. done

Note:

- The embedded part should be placed 1–3mm lower than the gypsum ceiling/drywall.
- Clean the hole edges while the paint is still wet, for better fitting of the light module.



- To secure safety, a qualified electrician is required to install/remove the luminaire.
- POWER OFF!!! NOT HOT PLUGGING!!!**