



NUORDIC
Interior Company



Cold-forged Aluminum Heat Sink.
Pure Aluminium Formed by Cold-forging and
CNC Anodizing finishing



COB LED Chip
Bridgelux CRI 97Ra
Deep hidden light source, anti-glare



Optic lens



Component for Vertical 25° Adjusting



Component for Horizontal 360° Adjusting



Aluminium Reflector
Superior light distribution compared to
plastic.



Magnetic
Permanent Rare Earth Magnet. Easily
assembles and disassembles, leaving an
hole for future driver maintenance

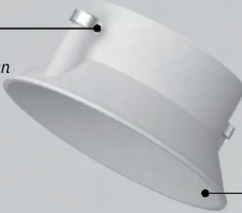

Options

| | Round | | | | | | Square | | Surface Mounted | |
|----------------------|---|----------|----------------------|-----------|--------------------|---|-----------------------------|---|----------------------------|--|
| Picture | | | | | | | | | | |
| Cutout Size | 75mm/2.95" | | | | | | 75*75mm/2.95"*2.95" | | / | |
| Power max. | 15W | 15W | 10W | 8W | 15W | 2*4W | 15W | | 10W | |
| Input Voltage | DC36V | | | | | 2*12VDC | DC36V | | DC36V | |
| CRI | 97Ra/90Ra | | | | | 90Ra | 97Ra/90Ra | | 97Ra/90Ra | |
| Lumens | 65lm/W / 90lm/W | | | | | 55lm/W | 65lm/W / 90lm/W | | 65lm/W / 90lm/W | |
| CCT | 3000K 3500K 4000K | | | | | 3000K 3500K 4000K | | 3000K 3500K 4000K | | |
| CCT Changeable | 2700K 6000K / 1800K 3000K | | | | | / | 2700K 6000K / 1800K 3000K | | | |
| Light Source | LED COB (Constant Current) | | | | | LED SMD (Constant Current) | LED COB (Constant Current) | | LED COB (Constant Current) | |
| Beam Angle | 15° 25° 35° 50° | 15° 25° | 15° 25° 35° | 15° 25° | 15° 25° 35° 50° | 15° 25° | 15° 25° 35° 50° | 15° 25° 35° 50° | 15° 25° 35° 50° | |
| Light Direction | 25° 360° | Fixed | 50° 360° | 20° 360° | 2*25° 360° | 25° 360° | Fixed | 20° 360° | | |
| IP Rating | IP20 | IP44 | IP20 | IP20 | IP20 | IP20 | IP20 | IP44 | IP20 | |
| Finishing Color | <input type="checkbox"/> Black <input type="checkbox"/> White | | | | | <input type="checkbox"/> Black <input type="checkbox"/> White | | <input type="checkbox"/> Black <input type="checkbox"/> White | | |
| Reflector Color | <input type="checkbox"/> Black <input type="checkbox"/> White <input type="checkbox"/> Golden <input type="checkbox"/> Black Mirror | | | | | <input type="checkbox"/> Black <input type="checkbox"/> White <input type="checkbox"/> Golden | | <input type="checkbox"/> Black <input type="checkbox"/> White <input type="checkbox"/> Golden | | |
| Material | Cold Forged Pure Alu. (Heat Sink)/Die-casting Alu. (Reflector&Embedded Part) | | | | | | | | | |
| Driver Voltage | AC100-120V AC220-240V | | | | | AC100-120V AC220-240V | | AC100-120V AC220-240V | | |
| Driver Options | ON/OFF | | DIM TRIAC/ PHASE-CUT | | | DIM 0/1-10V | | DIM DALI | | |
| Ceiling Applications | ·With Trim | | ·Trimless | | ·Semi-recessed | | ·Surface Mounted | | | |

Round Downlight

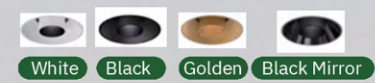
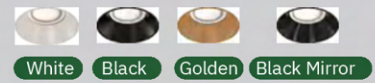
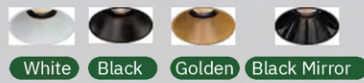
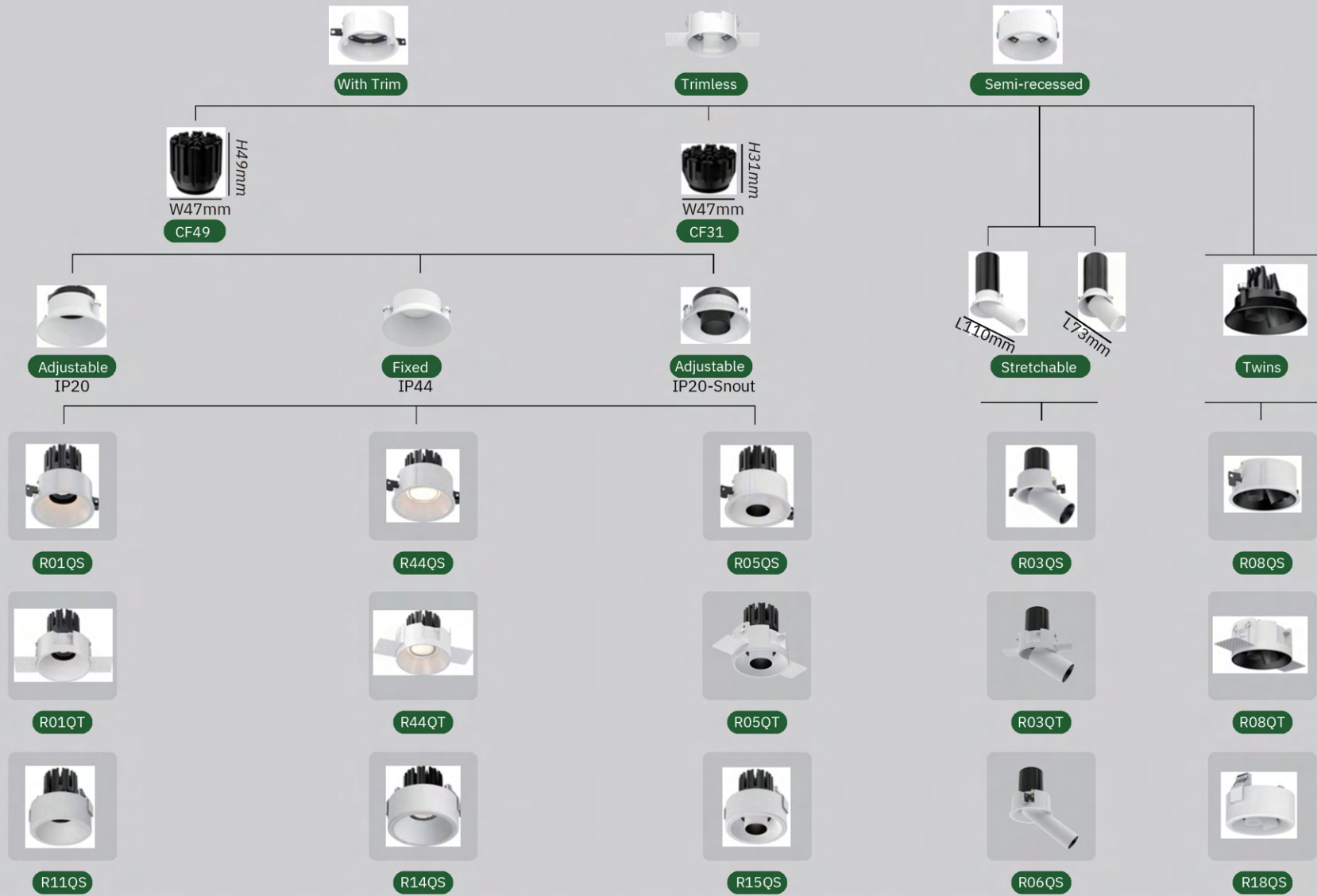

Round Adjustable

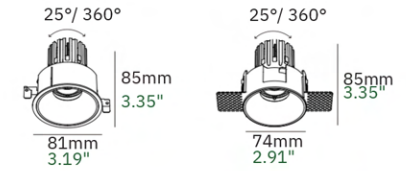
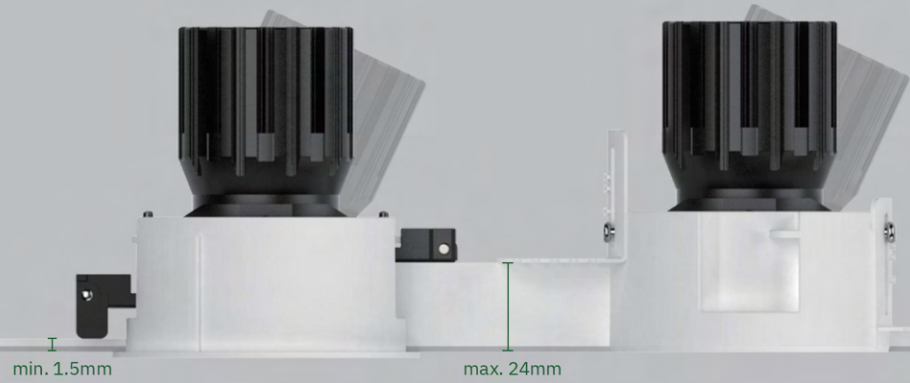

Basic Information

| | |
|----------------------|--|
| Embedded Parts | With Trim/Trimless |
| Mounting | Recessed |
| Trim Finishing Color | White/Black |
| Reflector Color | White/Black/Golden/ Black Mirror |
| Material | Cold Forged Pure Alu. (Heat Sink)/Die-casting Alu. |
| Cutout Size | 75mm |
| Light Direction | 25° 360° |
| IP Rating | IP20 |
| Power | Max. 15W |
| Input Voltage | DC36V |
| Input Current | Max. 350mA |

Optical Parameters

| | |
|-----------------|-------------------------|
| Light Source | LED COB |
| Lumens | 65lm/W 90lm/W |
| CRI | 97Ra / 90Ra |
| CCT | 3000K 3500K 4000K |
| CCT Changeable | 2700K 6000K 1800K 3000K |
| Beam Angle | 15° 25° 35° 50° |
| Shielding Angle | 50° |
| UGR | < 13 |
| LED Lifespan | 50000hrs |

Driver Voltage AC100-120V AC220-240V

Driver Options ON/OFF DIM TRIAC/ PHASE-CUT DIM 0/1-10V DIM DALI

With Trim

Trimless

White



Black



Golden

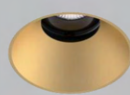
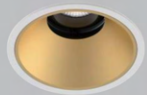

Stretchable Wide Spotlight

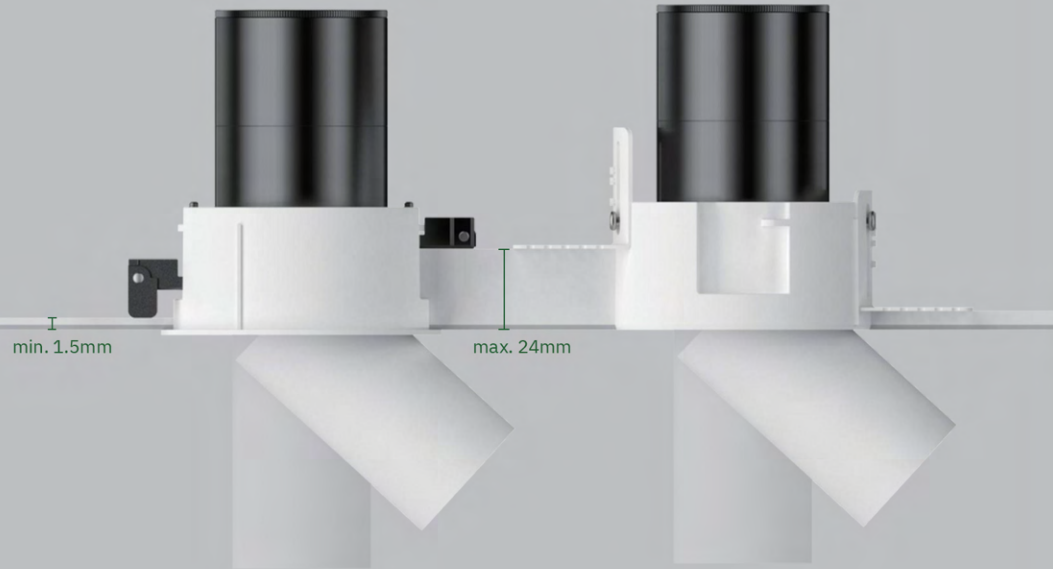

With Trim

Trimless

White



Black



Golden

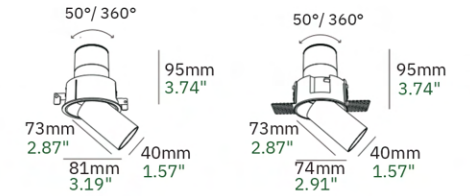

Basic Information

| | |
|----------------------|--|
| Embedded Parts | With Trim/Trimless |
| Mounting | Recessed |
| Trim Finishing Color | White/Black |
| Reflector Color | White/Black/Golden/ Black Mirror |
| Material | Pure Alu. (Heat Sink)/Die-casting Alu. |
| Cutout Size | 75mm |
| Light Direction | 50° 360° |
| IP Rating | IP20 |
| Power | Max. 10W |
| Input Voltage | DC36V |
| Input Current | Max. 250mA |

Optical Parameters

| | |
|-----------------|-------------------------|
| Light Source | LED COB |
| Lumens | 65lm/W 90lm/W |
| CRI | 97Ra / 90Ra |
| CCT | 3000K 3500K 4000K |
| CCT Changeable | 2700K 6000K 1800K 3000K |
| Beam Angle | 15° 25° |
| Shielding Angle | 45° |
| UGR | < 13 |
| LED Lifespan | 50000hrs |

Driver Voltage AC100-120V AC220-240V

Driver Options ON/OFF DIM TRIAC/ PHASE-CUT DIM 0/1-10V DIM DALI

Stretchable Spotlight

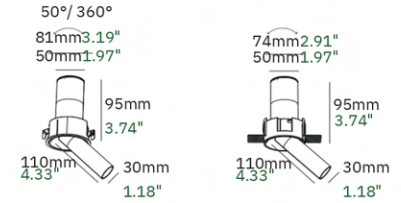

Basic Information

| | |
|----------------------|--|
| Embedded Parts | With Trim/Trimless |
| Mounting | Recessed |
| Trim Finishing Color | White/Black |
| Reflector Color | White/Black/Golden/ Black Mirror |
| Material | Pure Alu. (Heat Sink)/Die-casting Alu. |
| Cutout Size | 75mm |
| Light Direction | 50° / 360° |
| IP Rating | IP20 |
| Power | Max. 8W |
| Input Voltage | DC36V |
| Input Current | Max. 200mA |

Optical Parameters

| | |
|-----------------|-----------------------------|
| Light Source | LED COB |
| Lumens | 65lm/W 90lm/W |
| CRI | 97Ra / 90Ra |
| CCT | 3000K ● 3500K ● 4000K ● |
| CCT Changeable | 2700K — 6000K 1800K — 3000K |
| Beam Angle | 15° / 25° |
| Shielding Angle | 62° |
| UGR | < 9 |
| LED Lifespan | 50000hrs |

Driver Voltage AC100-120V AC220-240V

Driver Options ON/OFF DIM TRIAC/ PHASE-CUT DIM 0/1-10V DIM DALI

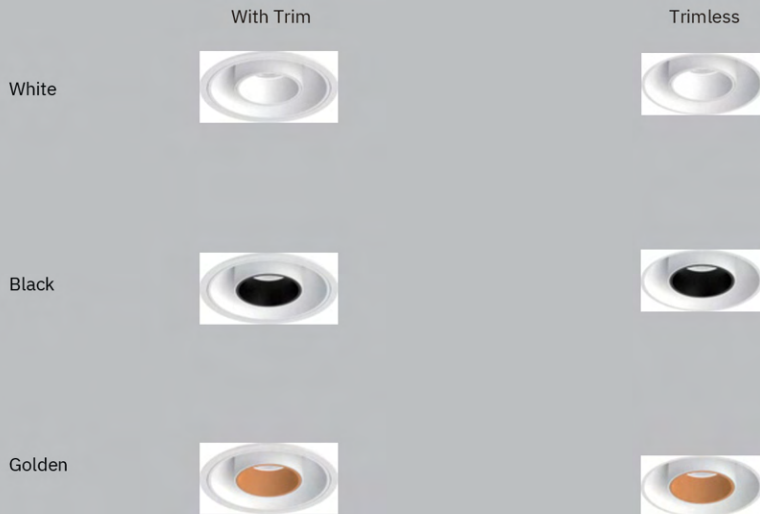

Flush Spotlight

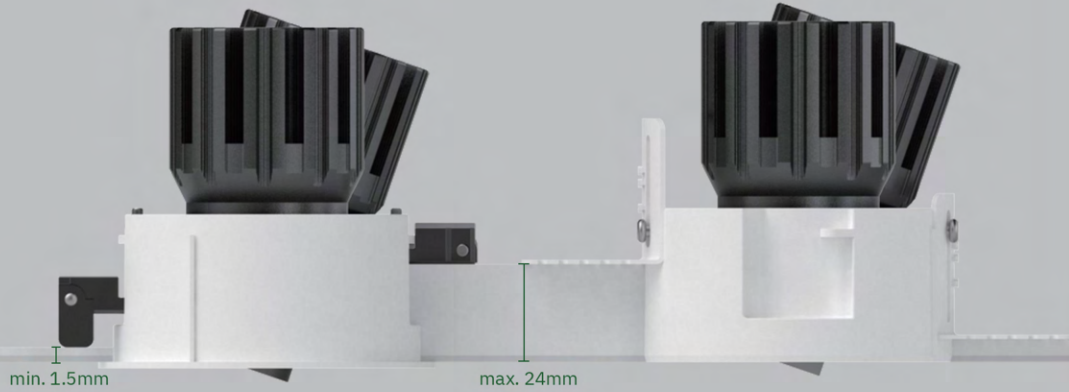

With Trim

Trimless

White

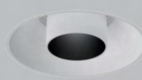
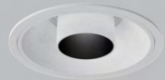

Black



Golden

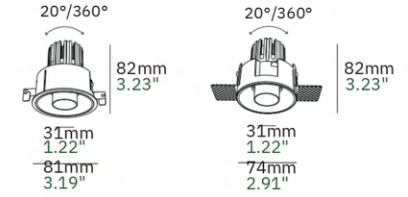

Basic Information

| | |
|----------------------|--|
| Embedded Parts | With Trim/Trimless |
| Mounting | Recessed |
| Trim Finishing Color | White/Black |
| Reflector Color | White/Black/Golden/ Black Mirror |
| Material | Cold Forged Pure Alu. (Heat Sink)/Die-casting Alu. |
| Cutout Size | 75mm |
| Light Direction | 20° 360° |
| IP Rating | IP20 |
| Power | Max. 15W |
| Input Voltage | DC36V |
| Input Current | Max. 350mA |

Optical Parameters

| | |
|-----------------|-------------------------|
| Light Source | LED COB |
| Lumens | 65lm/W 90lm/W |
| CRI | 97Ra / 90Ra |
| CCT | 3000K 3500K 4000K |
| CCT Changeable | 2700K 6000K 1800K 3000K |
| Beam Angle | 15° 25° 35° |
| Shielding Angle | 67° |
| UGR | < 9 |
| LED Lifespan | 50000hrs |

| | |
|----------------|--|
| Driver Voltage | AC100-120V AC220-240V |
| Driver Options | ON/OFF DIM TRIAC/ PHASE-CUT DIM 0/1-10V DIM DALI |

Double Mini Spotlight

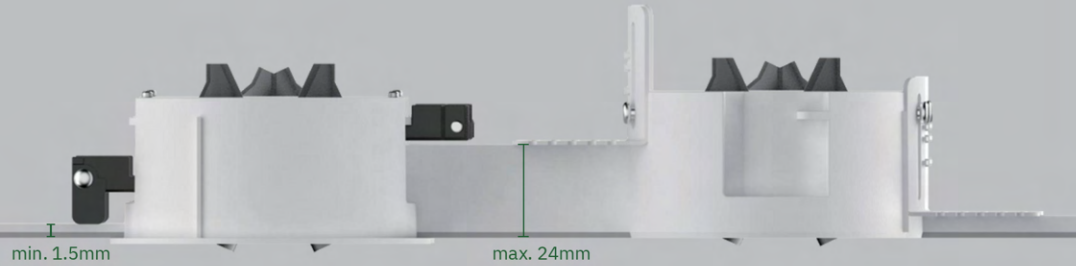
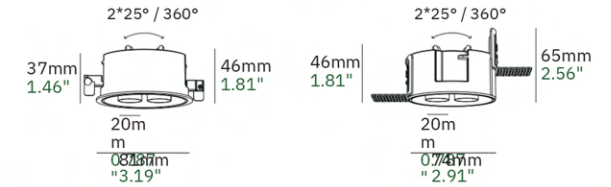

With Trim

Trimless

White



Black



Golden



Basic Information

| | |
|----------------------|--|
| Embedded Parts | With Trim/Trimless |
| Mounting | Recessed |
| Trim Finishing Color | White/Black |
| Reflector Color | White/Black/Golden/ Black Mirror |
| Material | Pure Alu. (Heat Sink)/Die-casting Alu. |
| Cutout Size | 75mm |
| Light Direction | 2*25° 360° |
| IP Rating | IP20 |
| Power | Max. 2*4W |
| Input Voltage | 2*12VDC |
| Input Current | Max. 600mA |

Optical Parameters

| | |
|--------------|-------------------|
| Light Source | LED COB |
| Lumens | 55lm/W |
| CRI | 90Ra |
| CCT | 3000K 3500K 4000K |
| Beam Angle | 15° 25° |
| LED Lifespan | 50000hrs |

Driver Voltage AC100-120V AC220-240V

Driver Options ON/OFF DIM TRIAC/ PHASE-CUT DIM 0/1-10V DIM DALI

Round Protruding

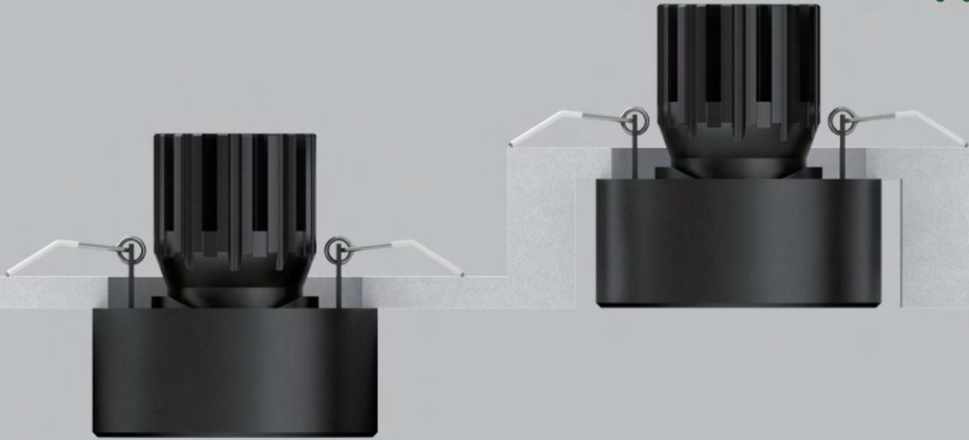

Basic Information

| | |
|------------|---|
| Model | |
| Mounting | Semi-recessed |
| Power | Max. 15W |
| CCT | 3000K ● 3500K ● 4000K ● |
| Beam Angle | 15° 25° 35° 50° |
| UGR | < 13 |
| IP Rating | IP20 |
| Lumens | 65lm/W 90lm/W |
| CRI | 97Ra /90Ra |

Driver Voltage AC100-120V AC220-240V

Driver Options ON/OFF DIM TRIAC/ PHASE-CUT DIM 0/1-10V

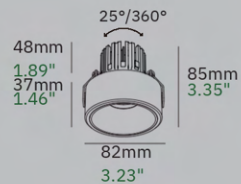

Round Protruding IP44



Basic Information

| | |
|------------|---|
| Model | |
| Mounting | Semi-recessed |
| Power | Max. 15W |
| CCT | 3000K ● 3500K ● 4000K ● |
| Beam Angle | 15° 25° 35° 50° |
| UGR | < 16 |
| IP Rating | IP44 |
| Lumens | 65lm/W 90lm/W |
| CRI | 97Ra /90Ra |

Driver Voltage AC100-120V AC220-240V

Driver Options ON/OFF DIM TRIAC/ PHASE-CUT DIM 0/1-10V



Square Downlights

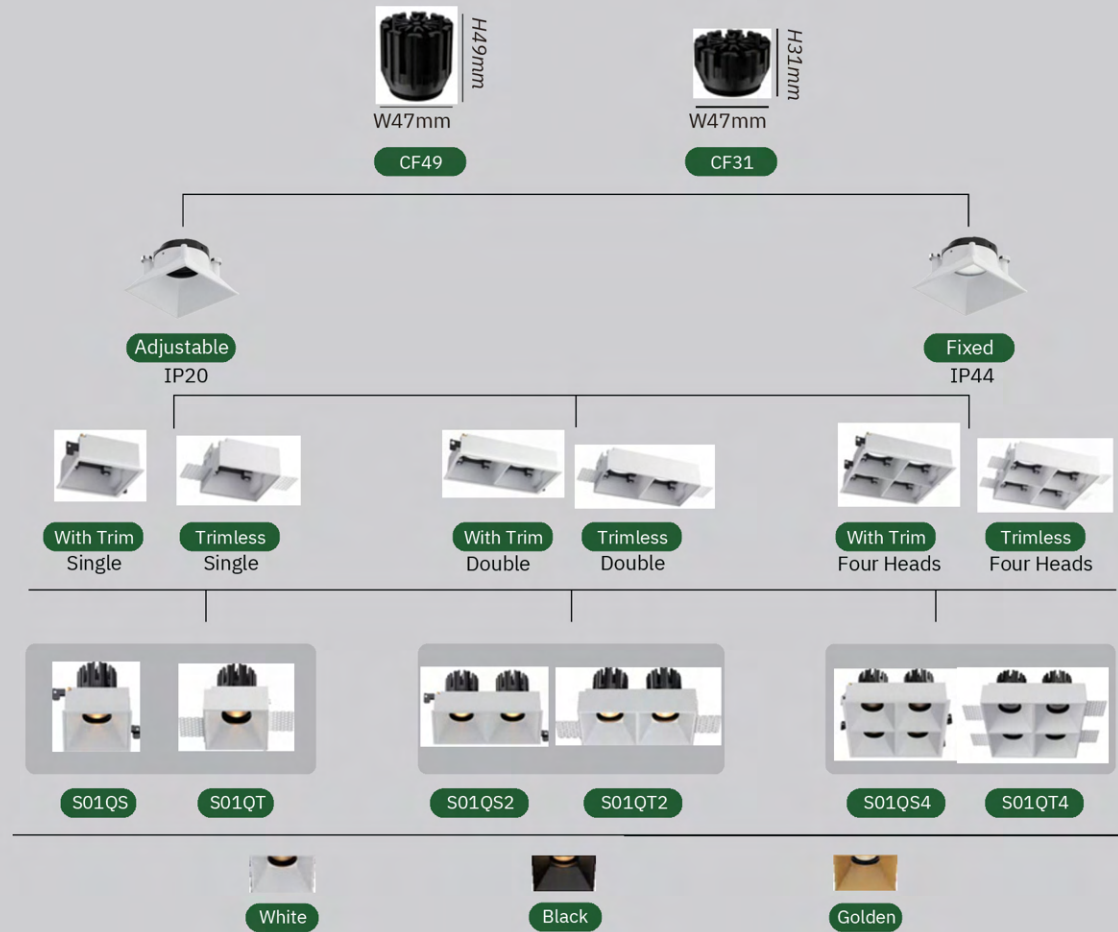

Square

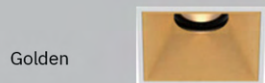
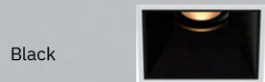
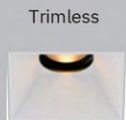
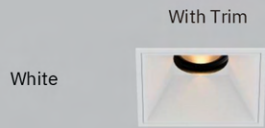
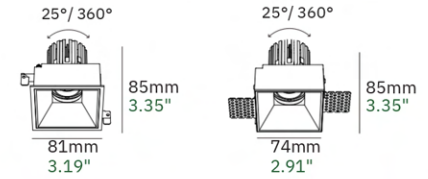
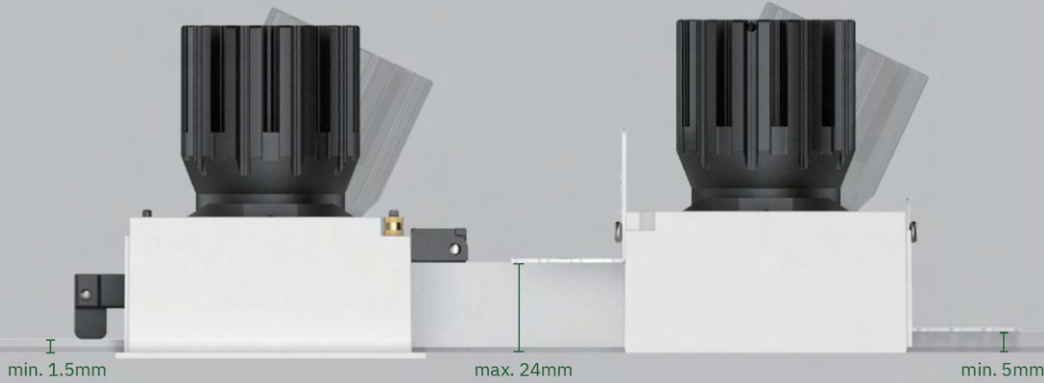

Basic Information

| | |
|----------------------|--|
| Embedded Parts | With Trim/Trimless |
| Mounting | Recessed |
| Trim Finishing Color | White/Black |
| Reflector Color | White/Black/Golden |
| Material | Cold Forged Pure Alu. (Heat Sink)/Die-casting Alu. |
| Cutout Size | 75*75mm |
| Light Direction | 25° 360° |
| IP Rating | IP20 |
| Power | Max. 15W |
| Input Voltage | DC36V |
| Input Current | Max. 350mA |

Optical Parameters

| | |
|-----------------|-------------------------|
| Light Source | LED COB |
| Lumens | 65lm/W 90lm/W |
| CRI | 97Ra / 90Ra |
| CCT | 3000K 3500K 4000K |
| CCT Changeable | 2700K 6000K 1800K 3000K |
| Beam Angle | 15° 25° 35° 50° |
| Shielding Angle | 50° |
| UGR | < 13 |
| LED Lifespan | 50000hrs |

Driver Voltage AC100-120V AC220-240V

Driver Options ON/OFF DIM TRIAC/ PHASE-CUT DIM 0/1-10V DIM DALI

Square Double / Quadruple

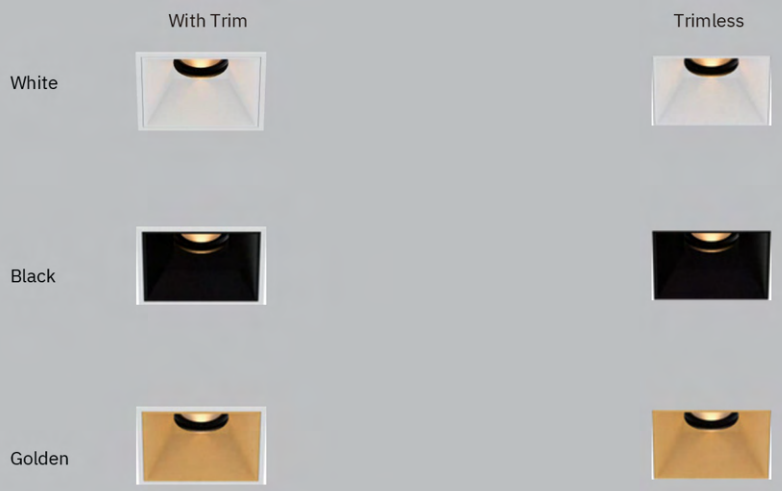
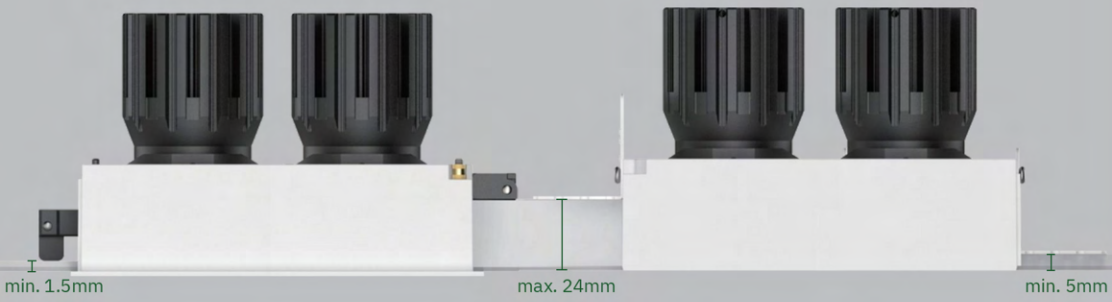
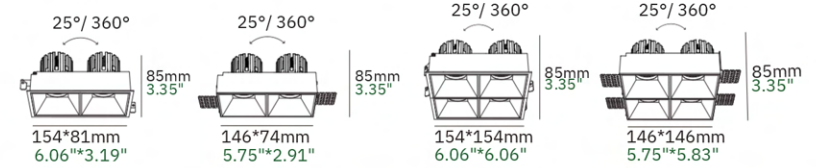

Basic Information

| | |
|----------------------|--|
| Embedded Parts | With Trim/Trimless |
| Mounting | Recessed |
| Trim Finishing Color | White/Black |
| Reflector Color | White/Black/Golden |
| Material | Cold Forged Pure Alu. (Heat Sink)/Die-casting Alu. |
| Cutout Size | 148*75mm/L148*148mm |
| Light Direction | 25° 360° |
| IP Rating | IP20 |
| Power | Max. 2*15W/4*15W |
| Input Voltage | DC36V |
| Input Current | Max. 2*350mA/4*350mA |

Optical Parameters

| | |
|-----------------|-----------------------------|
| Light Source | LED COB |
| Lumens | 65lm/W 90lm/W |
| CRI | 97Ra / 90Ra |
| CCT | 3000K ● 3500K ● 4000K ● |
| CCT Changeable | 2700K — 6000K 1800K — 3000K |
| Beam Angle | 15° 25° 35° 50° |
| Shielding Angle | 50° |
| UGR | < 13 |
| LED Lifespan | 50000hrs |

| | |
|----------------|--|
| Driver Voltage | AC100-120V AC220-240V |
| Driver Options | ON/OFF DIM TRIAC/ PHASE-CUT DIM 0/1-10V DIM DALI |

GEEK IP65

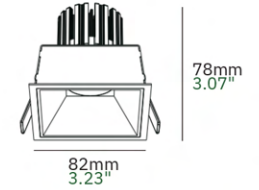

With Trim-White

With Trim-Black

White



Black



Golden



Basic Information

| | |
|----------------------|--|
| Embedded Parts | With Trim |
| Mounting | Recessed |
| Trim Finishing Color | White/Black |
| Reflector Color | White/Black/Golden |
| Material | Cold Forged Pure Alu. (Heat Sink)/Die-casting Alu. |
| Cutout Size | 75*75mm |
| Light Direction | Fixed |
| IP Rating | IP65 |
| Power | Max. 15W |
| Input Voltage | DC36V |
| Input Current | Max. 350mA |

Optical Parameters

| | |
|-----------------|-----------------------------|
| Light Source | LED COB |
| Lumens | 65lm/W 90lm/W |
| CRI | 97Ra / 90Ra |
| CCT | 3000K ● 3500K ● 4000K ● |
| CCT Changeable | 2700K — 6000K 1800K — 3000K |
| Beam Angle | 15° 25° 35° 50° |
| Shielding Angle | 35° |
| UGR | < 16 |
| LED Lifespan | 50000hrs |

Driver Voltage AC100-120V AC220-240V

Driver Options ON/OFF DIM TRIAC/ PHASE-CUT DIM 0/1-10V DIM DALI



CRI97



45mm Mini Spot



High Lumen



Fully Metal-made

Round 2 Inch

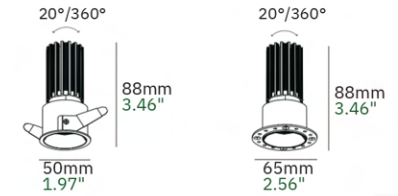

GENII Family

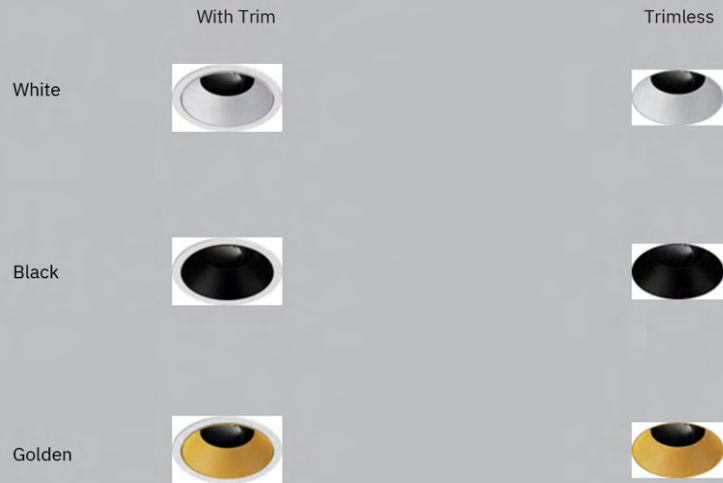
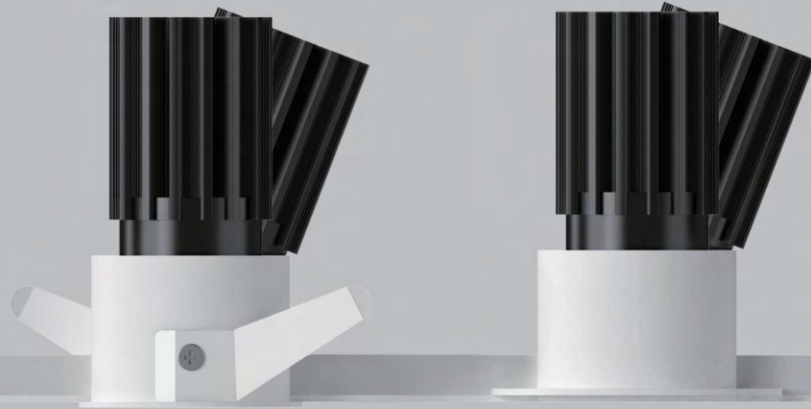

Basic Information

| | |
|----------------------|--|
| Embedded Parts | With Trim/Trimless |
| Mounting | Recessed |
| Trim Finishing Color | White/Black |
| Reflector Color | White/Black/Golden |
| Material | Cold Forged Pure Alu. (Heat Sink)/Die-casting Alu. |
| Cutout Size | 45mm |
| Light Direction | 20° 360° |
| IP Rating | IP20 |
| Power | Max. 10W |
| Input Voltage | DC36V |
| Input Current | Max. 250mA |

Optical Parameters

| | |
|-----------------|-------------------------|
| Light Source | LED COB |
| Lumens | 65lm/W 90lm/W |
| CRI | 97Ra / 90Ra |
| CCT | 3000K 3500K 4000K |
| CCT Changeable | 2700K 6000K 1800K 3000K |
| Beam Angle | 15° 25° 35° 50° |
| Shielding Angle | 52° |
| UGR | < 13 |
| LED Lifespan | 50000hrs |

| | |
|----------------|--|
| Driver Voltage | AC100-120V AC220-240V |
| Driver Options | ON/OFF DIM TRIAC/ PHASE-CUT DIM 0/1-10V DIM DALI |



Round Double

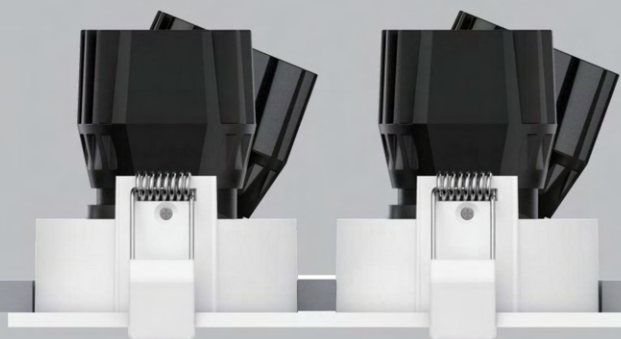

White

Black

White



Black



Basic Information

| | |
|----------------------|--------------------|
| Embedded Parts | With Trim |
| Mounting | Recessed |
| Trim Finishing Color | White/Black |
| Reflector Color | White/Black/Golden |
| Material | Aluminum |
| Cutout Size | 148*75mm |
| Light Direction | 25° 360° |
| IP Rating | IP20 |
| Power | Max. 2*12W |
| Input Voltage | DC36V |
| Input Current | Max. 2*300mA |

Optical Parameters

| | |
|-----------------|-------------------------|
| Light Source | LED COB |
| Lumens | 65lm/W 90lm/W |
| CRI | 97Ra / 90Ra |
| CCT | 3000K 3500K 4000K |
| CCT Changeable | 2700K 6000K 1800K 3000K |
| Beam Angle | 15° 25° 35° 50° |
| Shielding Angle | 46° |
| UGR | < 13 |
| LED Lifespan | 50000hrs |

Driver Voltage AC100-120V AC220-240V

Driver Options ON/OFF DIM TRIAC/ PHASE-CUT DIM 0/1-10V DIM DALI





GA55-R21QS



White



Black



Golden

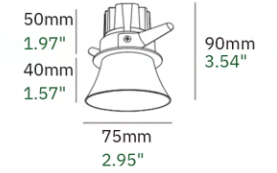

Basic Information

| | |
|----------------------|--------------------|
| Mounting | Semi-recessed |
| Trim Finishing Color | White/Black |
| Reflector Color | White/Black/Golden |
| Material | Aluminum |
| Cutout Size | 55mm |
| IP Rating | IP20 |
| Power | Max. 10W |
| Input Voltage | DC36V |
| Input Current | Max. 250mA |

Optical Parameters

| | |
|-----------------|-----------------------------|
| Light Source | LED COB |
| Lumens | 65lm/W 90lm/W |
| CRI | 97Ra / 90Ra |
| CCT | 3000K ● 3500K ● 4000K ● |
| CCT Changeable | 2700K — 6000K 1800K — 3000K |
| Beam Angle | 15° 25° 35° 50° |
| Shielding Angle | 55° |
| UGR | < 9 |
| LED Lifespan | 50000hrs |

Driver Voltage AC100-120V AC220-240V

Driver Options ON/OFF DIM TRIAC/ PHASE-CUT DIM 0/1-10V DIM DALI

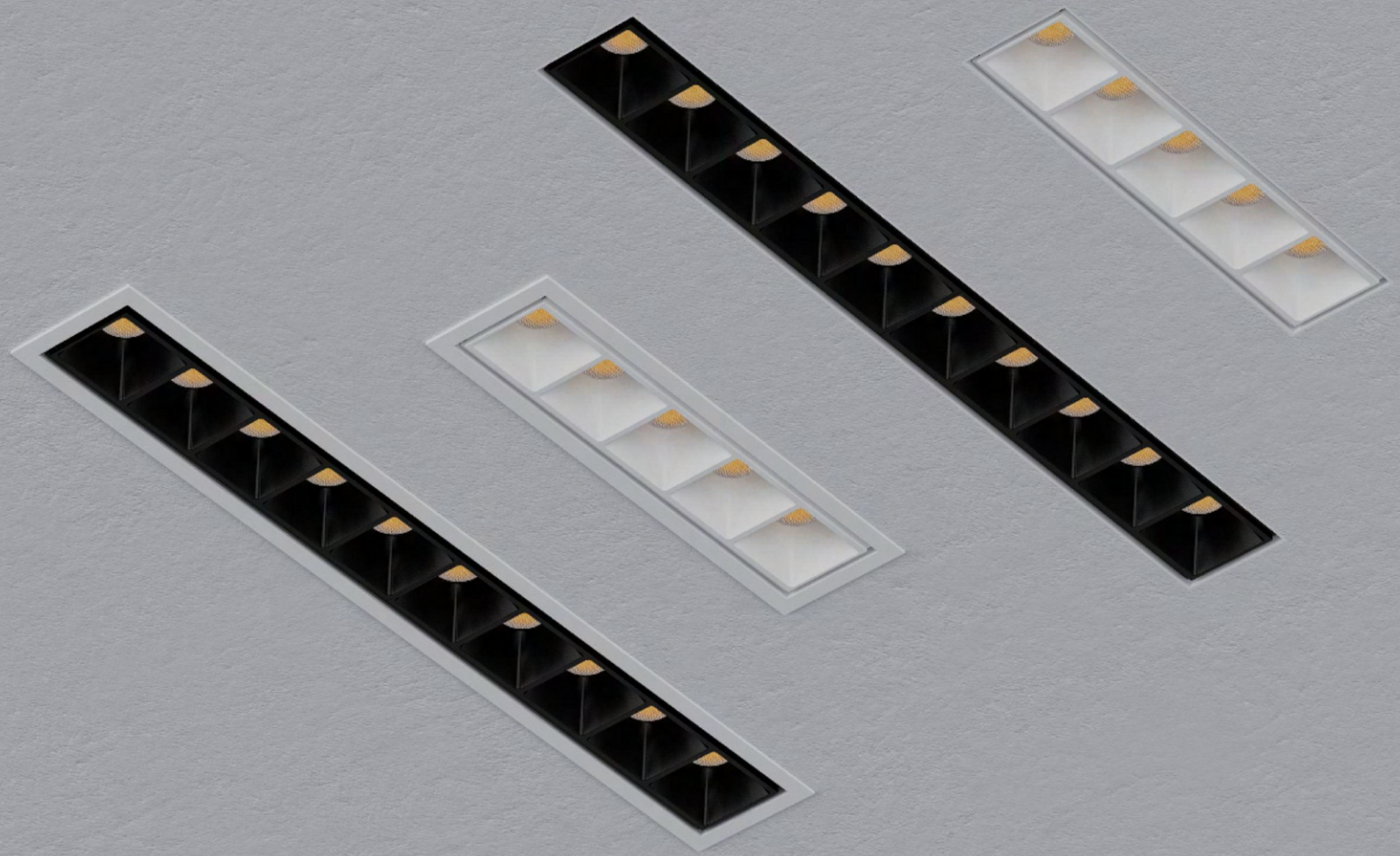

Linear 6 Inch



HIGH GRILLE SERIES

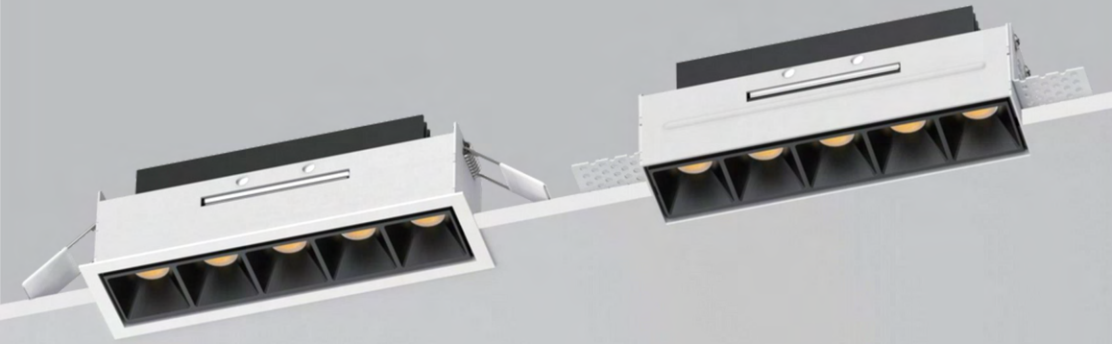

Basic Information

| | |
|----------------------|--------------------|
| Embedded Parts | With Trim/Trimless |
| Mounting | Recessed |
| Trim Finishing Color | White/Black |
| Reflector Color | White/Black |
| Material | Aluminum |
| Cutout Size | 163*44mm |
| IP Rating | IP20 |
| Power | Max. 12W |
| Input Voltage | DC15V |
| Input Current | Max. 750mA |

Optical Parameters

| | |
|----------------|-------------------------|
| Light Source | LED COB |
| Lumens | 67lm/W |
| CRI | 95Ra |
| CCT | 3000K ● 3500K ● 4000K ● |
| CCT Changeable | 2700K 6000K |
| Beam Angle | 50° |
| LED Lifespan | 50000hrs |

| | |
|----------------|--|
| Driver Voltage | AC100-120V AC220-240V |
| Driver Options | ON/OFF DIM TRIAC/ PHASE-CUT DIM 0/1-10V DIM DALI |

Linear 12 Inch



HIGH GRILLE SERIES



Basic Information

| | |
|----------------------|--------------------|
| Embedded Parts | With Trim/Trimless |
| Mounting | Recessed |
| Trim Finishing Color | White/Black |
| Reflector Color | White/Black |
| Material | Aluminum |
| Cutout Size | 319*44mm |
| IP Rating | IP20 |
| Power | Max. 24W |
| Input Voltage | DC30V |
| Input Current | Max. 750mA |

Optical Parameters

| | |
|----------------|-------------------------|
| Light Source | LED COB |
| Lumens | 67lm/W |
| CRI | 95Ra |
| CCT | 3000K ● 3500K ● 4000K ● |
| CCT Changeable | 2700K 6000K |
| Beam Angle | 50° |
| LED Lifespan | 50000hrs |



| | |
|----------------|--|
| Driver Voltage | AC100-120V AC220-240V |
| Driver Options | ON/OFF DIM TRIAC/ PHASE-CUT DIM 0/1-10V DIM DALI |



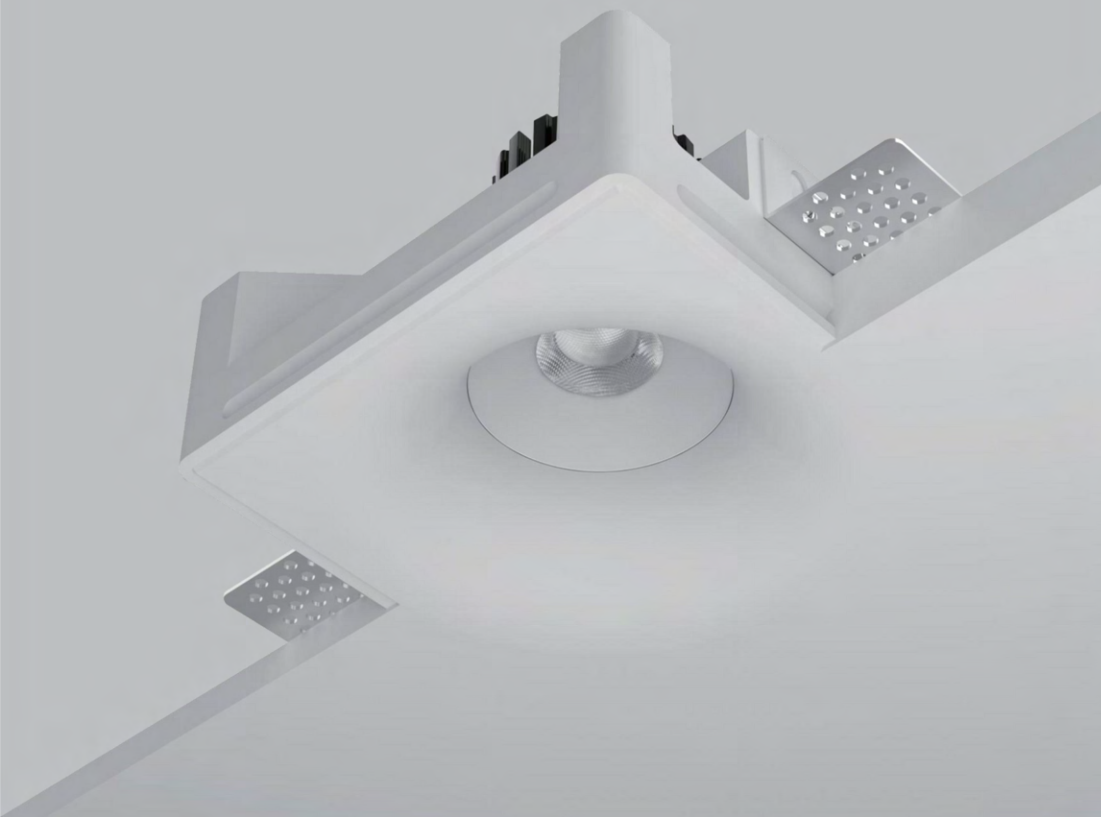
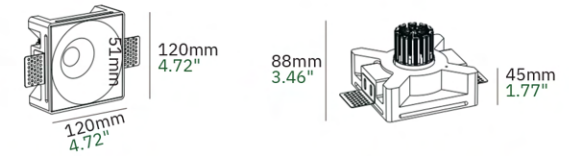

Split Design LED COB Light Source Cold Forged Pure Alu. Heat Sink

Basic Information

| | |
|----------------------|--------------------------------------|
| Embedded Parts | Trimless |
| Mounting | Recessed |
| Trim Finishing Color | White |
| Reflector Color | White |
| Material | Gypsum Housing, Aluminium Light Body |
| Cutout Size | 123*123mm |
| IP Rating | IP20 |
| Power | Max. 15W |
| Input Voltage | DC36V |
| Input Current | Max. 350mA |

Optical Parameters

| | |
|-----------------|-----------------------------|
| Light Source | LED COB |
| Lumens | 65lm/W |
| CRI | 97Ra |
| CCT | 3000K ● 3500K ● 4000K ● |
| CCT Changeable | 2700K — 6000K 1800K — 3000K |
| Beam Angle | 25° 60° |
| Shielding Angle | 39° |
| LED Lifespan | 50000hrs |

| | |
|----------------|---|
| Driver Voltage | AC100-120V AC220-240V |
| Driver Options | ON/OFF DIM TRIAC/ PHASE-CUT DIM 0/1-10V DIM DALI |