



N45-R06



N45-R06

1" Adjustable

Recessed Adjustable Downlight · Round · N12-R25

6 W

90+ CRI

15° / 25° BEAM

ETL LISTED

DRY LOCATION

HOW TO ORDER

Ordering example: N75-R07QT-W-B-B-97-35-45

N75	R	07	QT	W	B	B	97	35	45
MODEL	SHAPE	VERSION	TRIM	FRAME	REFLECTOR	LED CHIP	CRI	CCT	BEAM

1" Adjustable	SHAPE	VER.	TRIM	FRAME FINISH	REFL. FINISH	LED CHIP	CRI / LUMENS	CCT	BEAM	DIMMING	ACCESSORIES
N45	R	01	QS Microflange	B Black	B Black	B Bridge	90 90+ CRI 10 Watts Lumens Divd-990	27 2700K	50 50° 35 35° 25 25°	CMEM55 On/Off; Triac Phase Dim; 120 VAC KIG On/Off; Triac Phase Dim; 120/277 VAC <i>*Remote placed</i> <i>*DALI 2ch driver, remote placed (tunable white)</i>	NCP-R55 Non-IC bracket NCBX-R55 IC box BRKT-2R55 Non-IC bracket for dual lights <i>*For details, see page 3</i>
			QT Trimless Drywall	W White	W White	97 97+ CRI 10 Watts Lumens Divd-700	30 3000K				
					G Golden		35 3500K				
					B Black Mirror		40 4000K				
						Dim To Warm	1830 1800-3000K				
						90 90+ CRI · 10 W Lumens Divd.650		2765A 2700K 3000K 4000K 5000K			
						90 90+ CRI · 10 W Lumens Divd-760 <i>External 5CCT Selector</i>		2765 2700-6700K			
ORDERING EXAMPLE N75-R07QT-W-B-B-97-35-45											

1" Adjustable

Photometry

Beam Angle	50°
Delivered Lumens	990 lm
CCT	4000K
CRI	90
Power	10 W
Efficacy	99 lm/W

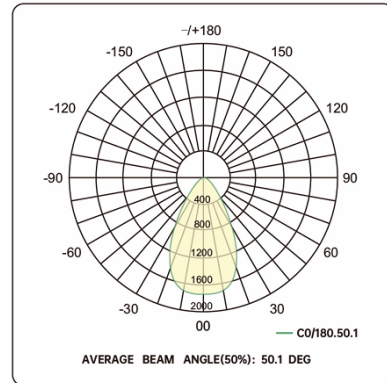

Beam Angle	35°
Delivered Lumens	920 lm
CCT	4000K
CRI	90
Power	10 W
Efficacy	92 lm/W

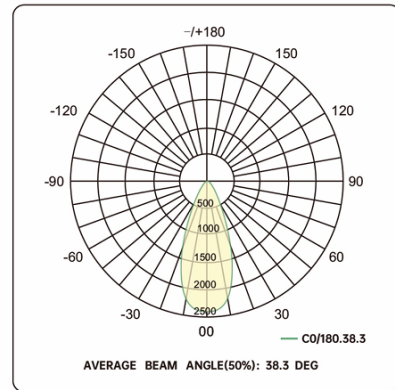

Beam Angle	25°
Delivered Lumens	630 lm
CCT	4000K
CRI	97
Power	10 W
Efficacy	63 lm/W

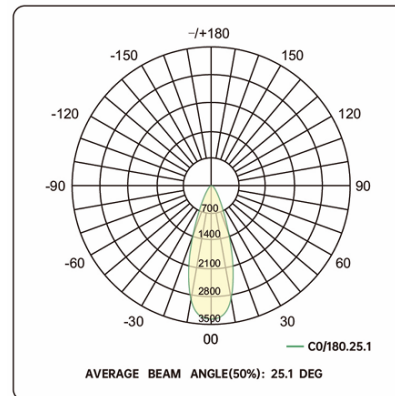

1" Adjustable

Accessories

Brackets for New-Construction (4-legs)



NCP-SR3-R21

Cutout:

- Round: Ø3" (Ø 77mm)
- Ø2" (Ø 62mm)
- Ø1" (Ø 50mm)

Square: □3" (□ 77mm)

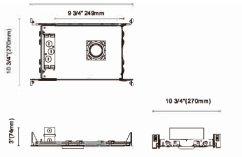

IC-BOX for New-Construction (4-legs)

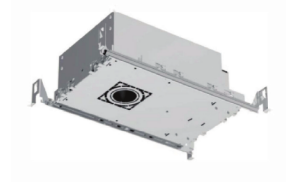

NCBX-SR3-R21

Cutout:

- Round: Ø3" (Ø 77mm)
- Ø2" (Ø 62mm)
- Ø1" (Ø 50mm)

Square: □3" (□ 77mm)

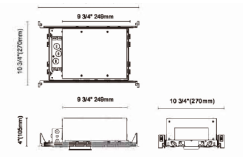

Cut out

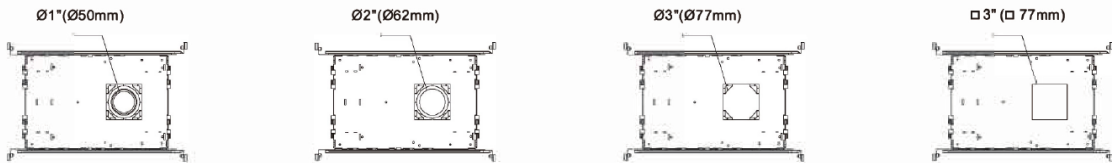

Brackets for New-Construction



BRKT -2R50A

trim & trimless

Cut out:

Round: Ø 1"×2 (Ø 50mm×2)

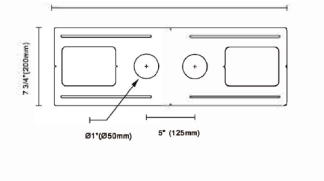

Remark

Tailored brackets are available with a reasonable surcharge, details as below

- The customized bracket dimensions are still the same as the existing ones, 600*200mm
- Hole sizes can be customized within the range of 25-100mm
- Holes quantity can be indicated, 1-7pcs
- Holes' positions on the bracket can be done as requests

For more information, please get in touch with sales.

1" Adjustable

Dimensions

N45 - R01

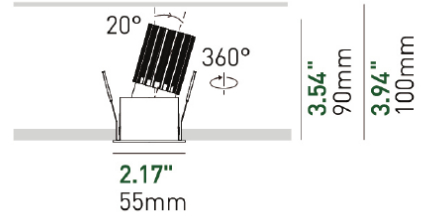
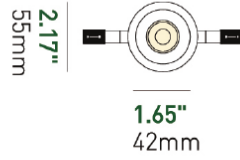
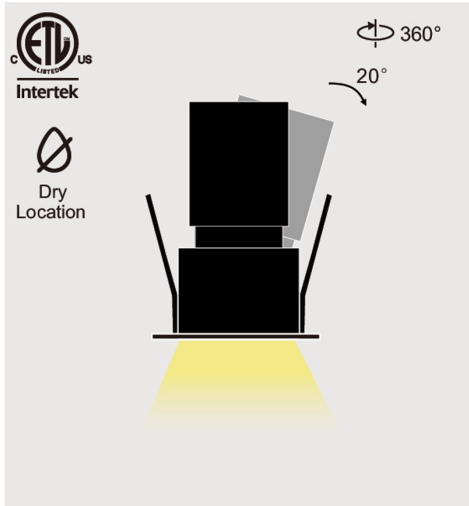

N45 - R01

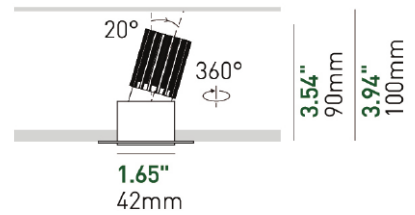
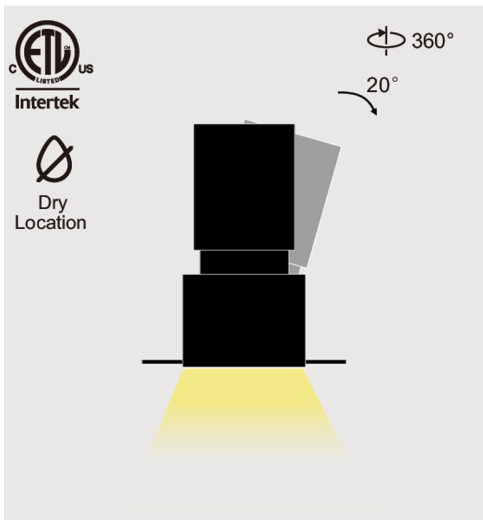

1" Adjustable

Microflange

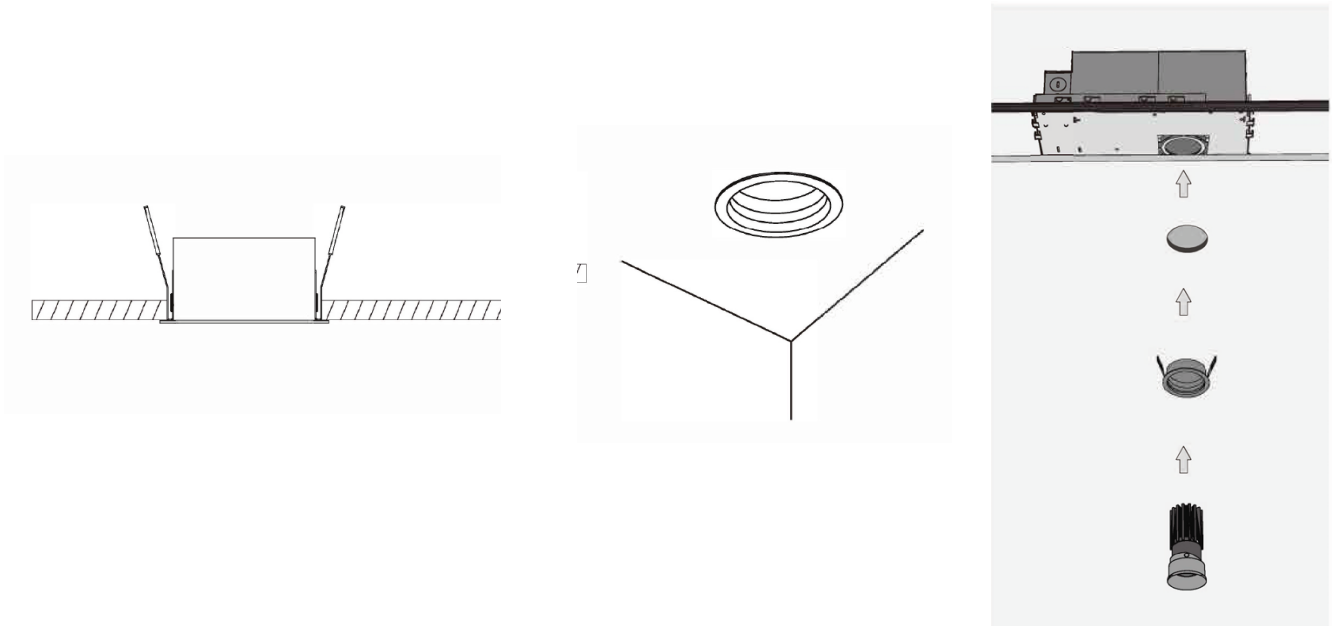

Trimless Drywall

