

Installation Instructions

NCP-Series

Non-IC Bracket

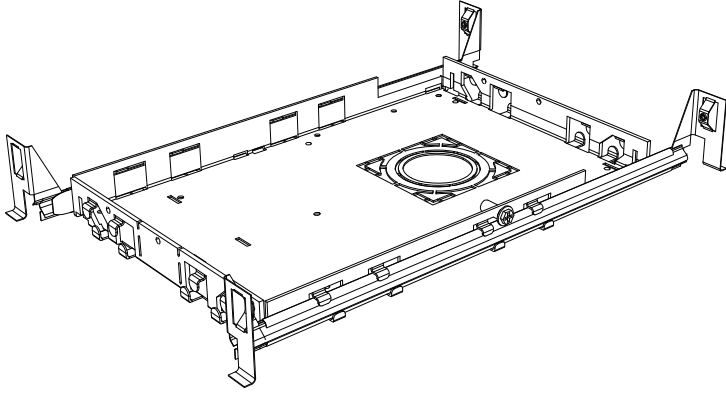

Safety Information

For your safety, read and understand these instructions completely before starting installation.

The electrical product contained herein is designed to meet the requirements of UL 1598 and the current NFP regulations as published in the NEC. Specific modifications and revisions in your area may differ from this standard. Compliance with local building and electrical codes must be confirmed before installation.

WARNING - To prevent wiring damage or abrasion, do not pinch or damage exposed wiring during installation. Keep away from edges of sheet metal or other sharp objects.

WARNING -Risk of fire or electric shock. Installation of this retrofit assembly requires a person familiar with the construction and operation of the luminaire's electrical system and the hazard involved. If not qualified, do not attempt installation. Contact a qualified electrician.

WARNING - Risk of fire or electric shock. Install this kit only in the luminaires that have the construction features shown in the photographs and / or drawings. Do not make or alter any open holes in an enclosure of wiring or electrical components during kit installation.

WARNING - Risk of fire or electric shock. Do not alter, relocate or remove wiring, lampholders, power supply, or any other electrical component.

Pre-Installation

Power to luminaire power must be turned off prior to installation. Failure to do so may cause electric shock, which may result in injury or death. Ensure that electrical connection is in accordance with local and NEC standards and that wiring is either 120VAC or 277VAC.

Installation in Joist or Stud

- 1 Locate fixture position.
- 2 Install bar hanger ends into joists by screwing in four screws (factory installed) at the end of the bar hangers. Note: Compatible with 14" - 23 1/2" spacing.



- 3 Adjust horizontal position of junction Non-IC Bracket by sliding it along bar hangers. Locate center according to fixture location.



- 4 Lock horizontal positioning by fastening two bar hanger screws (factory installed).

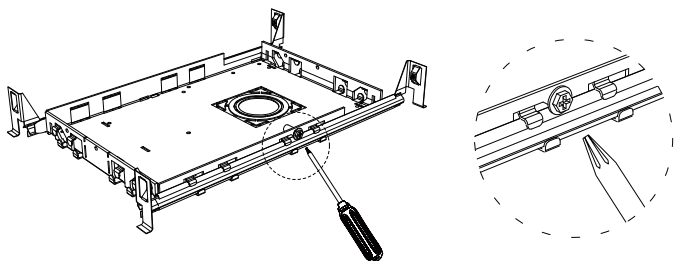

Module Installation

- 1 Use tools to cut those that fit the size of the lights. Note: Sizes include 3" 2", 1" round, and 3" square.

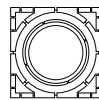
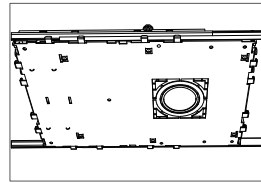

1"Round

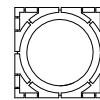

2"Round

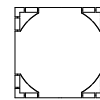

3"Round

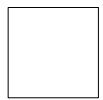

3"Square

- 2 Please make sure to have a power cord ready in advance.

- 3 Mark center fixture position on drywall.

- 4 Start from the center and cut out an appropriately sized hole for the light fixture along the outer contour.

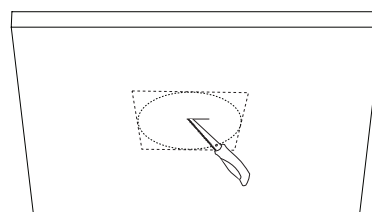

Round light fixture opens round hole

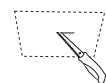

Square light fixture opens square hole

Light Fixture Installation

- 1 Install the embedded part.

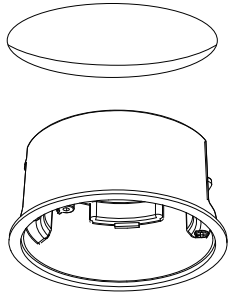

- 2 Screwed the mount part at a proper position to fit the ceiling board thickness

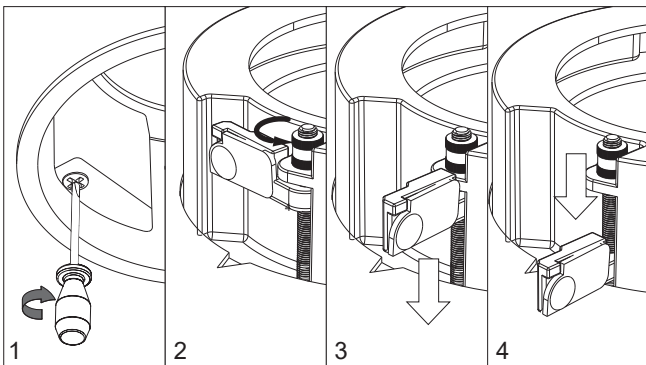

- 3 Wire the driver.

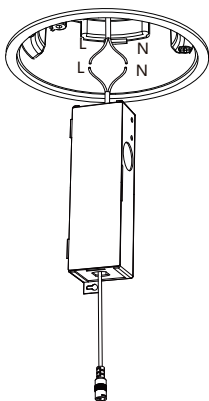

- 4 Plug in the light and buckle the safety rope.

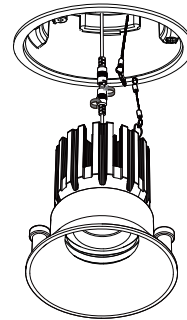

- 5 Fix the light on by magnet.

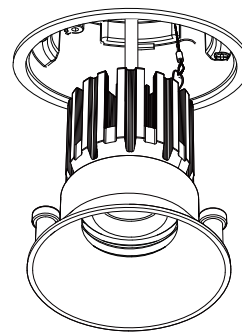

- 6 Done.

